



LEAPERS<sup>®</sup>, INC.

**OPTICS**

**USER MANUAL**

**Complete Installation and  
Operating Instructions**

[WWW.LEAPERS.COM](http://WWW.LEAPERS.COM)

# LEAPERS<sup>®</sup> INC.

Proudly Presents



## OPTICS

RANGE  
ESTIMATING SCOPES

RETICLE  
INTENSIFIED SCOPES

### TOTAL SOLUTION TO YOUR NEEDS

-COMMITMENT TO BEST QUALITY, BEST VALUE AND BEST SERVICE-

[www.LEAPERS.com](http://www.LEAPERS.com)  
32700 Capitol Street, Livonia, MI 48150, U.S.A.  
Tel: (734) 542-1500  
Fax: (734) 542-7095  
Email: [office@leapers.com](mailto:office@leapers.com)

## Index

A. Scope Parts Illustration .....	4
B. Major Features .....	7
C. Mounting the Scope .....	8
D. Understanding the Reticle .....	10
E. Adjusting Diopter .....	12
F. Installing Battery .....	12
G. Adjusting Reticle Illumination .....	12
H. Adjusting Magnification .....	13
I. Adjusting Parallax and Focus .....	13
J. Zeroing .....	14
K. Installing Sunshade .....	18
L. Care And Maintenance .....	18
M. Limited Lifetime Manufacturer's Warranty .....	18

## A. SCOPE PARTS ILLUSTRATION

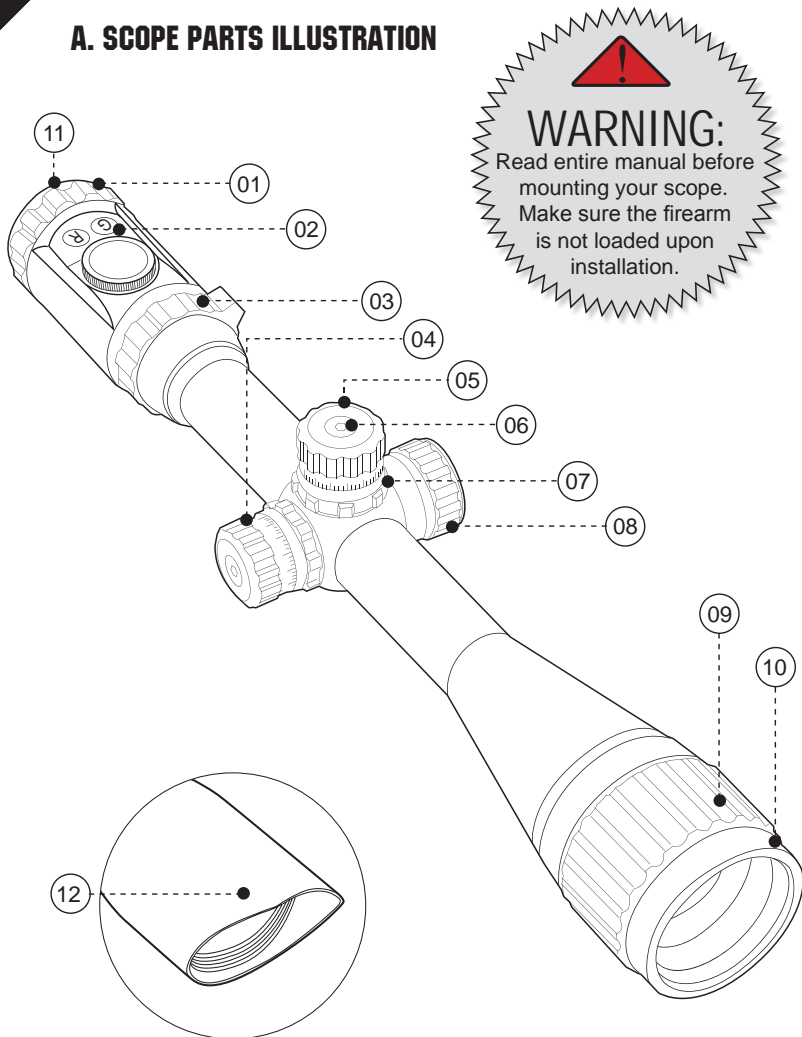

## PARTS LIST

- 01. Eyepiece Assembly
- 02. EZ-TAP Control Panel (For Reticle Illuminated Scopes with IE Capability)
- 03. Power Ring (For Variable Power Scopes Only)
- 04. Windage Adjustment Knob
- 05. Elevation Adjustment Knob
- 06. Adjustment Hex Screw (Optional)
- 07. Zero Locking Ring (Optional)
- 08. Reticle Illumination Adjustment (For Reticle Intensified Models Only) or Parallax Adjustment Ring (For Side AO Models Only)
- 09. Objective Parallax Adjustment Ring (For Front AO Models Only)
- 10. Objective Lens Protective Ring (Optional, Needs to Remove in Order to Install Sunshade)
- 11. Ocular Lens
- 12. Integral Sunshade (For Models with Angled Objective)

### Note:

Scope diagram is for illustration purposes only, not intended to represent your actual product appearance.

## ACCESSORIES

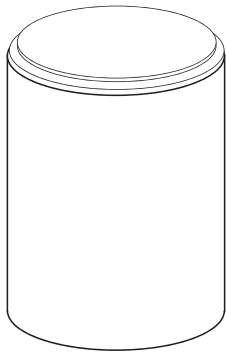

Optional - 3" Sunshade  
(for 50mm Obj. Dia. Scope)

Optional - 2.5" Sunshade  
(for 40mm Obj. Dia. Scope)

Optional - 2" Sunshade  
(for 32mm Obj. Dia. Scope)

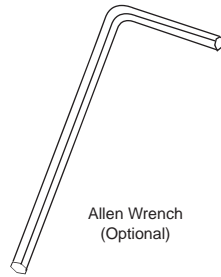

Allen Wrench  
(Optional)



Battery  
(For Reticle Intensified  
Models Only)

Flip-open Lens Caps  
(Style May Vary)

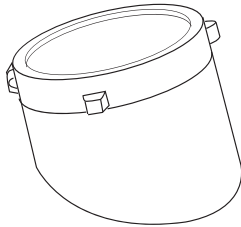
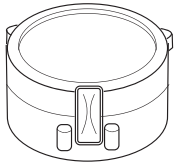

Cleaning Cloth

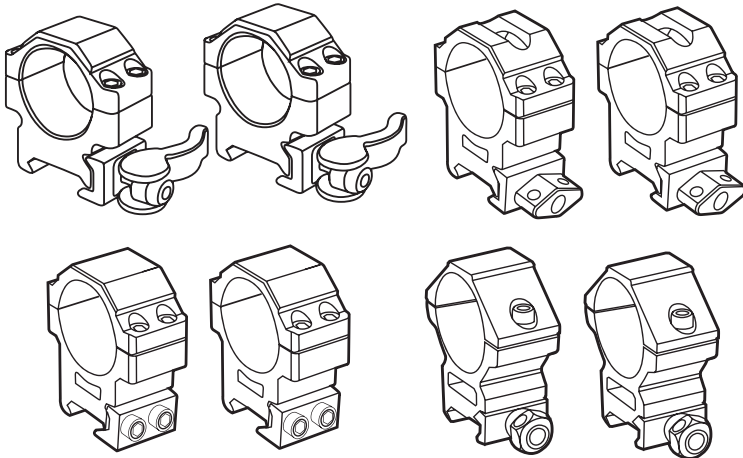
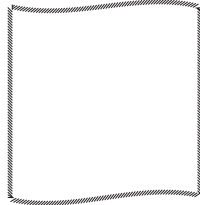

Mounting Rings  
(Appearance May Vary. Not All Models Include Rings.)

## B. MAJOR FEATURES

### ► **Built on True Strength Platform, Completely Sealed and Nitrogen Filled, Shockproof, Fogproof and Rainproof**

- Rugged one piece tube construction for all terrains/weather.
- Smart spherical structure (SSS) to achieve the most responsive, precise and reliable windage and elevation adjustment.
- Precision machined to exact tolerances from aircraft-grade aluminum alloy to achieve the desired performance under most heavy recoil.
- Completely sealed and nitrogen filled to eliminate risk of water ingress and fogging.
- Positive and precise click value for accurate and consistent shooting.
- Most disciplined quality control and extensive shock and vibration testing to guarantee optimal recoil resistance capability and consistent performance.

### ► **Multi Layer Lens Coating for Optimum Light Transmission** (For Target Turret Models Only)

- Unique high tech coatings applied to lens elements ensure best light transmission for optimal optical performance.
- Multi layer coatings ensure maximum utilization of all ambient light for the best resolution and clarity.

### ► **Target Turrets with Unique Zero Locking and Zero Resetting Features**

- Most innovative design for user friendly W/E control.
- Easy and repeatable Zero Locking and Zero Resetting provides the most needed protection and convenience.

### ► **Wide Field of View and Tactical Mil-Dot Reticle (For Range Estimating Models Only)**

- Wide field of view and edge to edge lens clarity makes it easy to pick up quarry on the peripheral edge of the sight image.
- The precise tactical Mil-Dot reticle allows the shooter to estimate ranges for most optimal aiming and shooting performance.

### ► **High Quality Precision Machined Parts**

- Precision machined parts guarantees smooth and accurate operations and delivers consistent and reliable performance.

### ► **Illuminated Reticle with Red/Green Dual or 36-color IE Illumination(For Reticle Intensified Models Only)**

- Adjustable color and intensity of the illuminated reticle gives optimum reticle clarity in variable light conditions, increasing accuracy in daylight and twilight environments.

## C. MOUNTING THE SCOPE

**CAUTION:** Always ensure your rifle is UNLOADED, UNCOCKED and, where applicable, the safety catch is applied before fitting the scope. Practice safe handling procedures at all times.

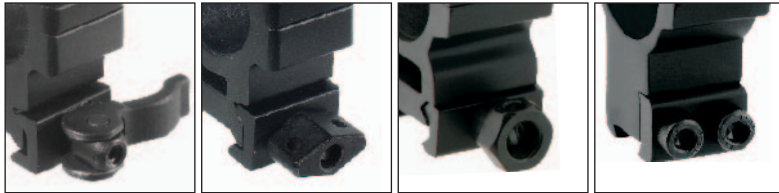

C-1. QD Lever Lock

C-2. Twist Lock

C-3. Thumb Nut Lock

C-4. Hex Screw Lock

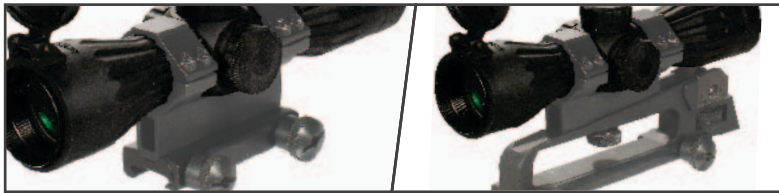

C-5. Flat Top or Carry Handle Mount

Ensure you have top quality rings from UTG. Buying cheap rings is a false economy and can result in poor performance from your combo.

### ★ For Mounting Rings as shown in C-1



Turn the Cam Lever leftward to its unlocked position. Place the QD ring on the Picatinny rail at a desired position. Seat the cross bolt at the bottom of the ring into a selected Picatinny slot.



Turn the Cam Lever from left to right to begin locking the QD ring on the rail, but do not complete the locking motion, leaving some travel distance to allow for adjustment.



Use the included Allen wrench to adjust the Hex Screw at the side of the cam for proper tension and fit against the rail. Adjust clockwise to increase the tension and tighten the clamping width. Adjust counter-clockwise to decrease the tension and increase the clamping width.



The optimal tension is achieved when the side plate first makes contact with the Picatinny rail while the Cam Lever still has enough travel left for you to securely snap into its locking position. Once you achieve the optimal tension, push the Cam Lever all the way to the right for a positive lock onto the rail. You may repeat Step 3 and 4 if needed to find the best clamping tension and locking position for your rings on the rail.



Remove the top half of the ring by loosening the screws and slowly backing them out.



Place your scope on the ring bases. Put the rifle to your shoulder in your natural shooting position and adjust the scope eye relief until you achieve a full field of view.

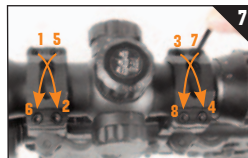

### ★ For Mounting Rings as shown in C-2 and C-3

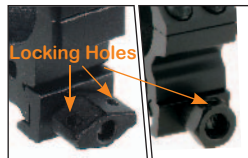

Replace the top ring halves and tighten the screws evenly by the Cross-torque Pattern. Do not over-tighten the screws as damage to scope tube may occur. It is recommended to grasp the Allen wrench by its short end to perform final tightening of the screws with torque value at about 15 inch-lb. Using the long end of the Allen wrench to tighten ring screws will result in over-tightening and may cause permanent damage to rings and deformation of scope tube. The scope is now ready to be zeroed.

1. Fit the ring bases to the mount rail of the rifle.
2. Tighten the Twist Lock or the Thumb Nut with your finger. To ensure a firm grip, plug the long end of the Allen Wrench into the Locking Holes and further tighten it by turning the short end.
3. Remove the top piece of the ring and place the scope on the exposed fitted ring bases. Replace the top piece of the ring and finger tighten.
4. Put the rifle to your shoulder in your natural shooting position and adjust the scope eye relief until you achieve a full field of view.
5. When you have found the ideal eye relief, rotate the scope so the reticle crosshair is vertical and perpendicular to the rifle.
6. Tighten the screws on the rings to by following Step 7 of C-1 ring instruction. Ensure a firm grip on the scope. Using the long end of the Allen wrench to tighten ring screws will result in over-tightening and may cause permanent damage to rings and deformation of scope tube. The scope is now ready to be zeroed.

### ★ For Mounting Rings as shown in C-4

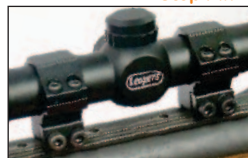
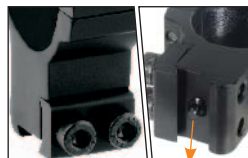

1. Fit the ring bases to the mount rail of the rifle.
2. Make sure the Stop Pin fully sink into the position hole on the rail if applicable. Insert the short end of the Allen Wrench into the screws and fully tighten by turning the long end and ensure a firm grip.
3. Remove the top piece of the ring and place the scope on the exposed fitted ring bases. Replace the top piece of the ring and finger tighten.
4. Put the rifle to your shoulder in your natural shooting position and adjust the scope eye relief until you achieve a full field of view.
5. When you have found the ideal eye relief, rotate the scope so the reticle crosshair is vertical and perpendicular to the rifle.
6. Tighten the screws on the ring to by following Step 7 of C-1 ring instruction. Ensure a firm grip on the scope. Using the long end of the Allen wrench to tighten ring screws will result in over-tightening and may cause permanent damage to rings and deformation of scope tube. The scope is now ready to be zeroed.

### ★ For Mounting Deck as shown in C-5



1. Firearm with Carry Handle:
  - 1) Place the integral mounting deck of the scope into the carry handle of your firearm.
  - 2) Align one of the holes on the mounting deck with the hole on the carry handle for best eye relief.
  - 3) Insert the knurled thumb nut with the integral bolt through the O-ring and the hole selected from the underside of the carry handle and tighten the nut.
2. Rifle with Picatinny/Weaver Flat Top:
  - 1) Attach the integral mounting deck of the scope onto the Picatinny Flat Top Adaptor with the supplied screws.
  - 2) Place the assembled scope/flat top adaptor combo onto the Picatinny/Weaver flat top rail on your rifle and adjust for best eye relief position.
  - 3) Secure the combo by tightening the two thumb nuts on the side of the Flat Top Adaptor.
3. Firearm with .22/Airgun Flat Top:
  - 1) Attach the integral mounting deck of the scope onto the .22/Airgun Flat Top Adaptor with the supplied screws.
  - 2) Place the assembled scope/Flat Top Adaptor combo onto the .22/Airgun flat top rail on your rifle and adjust for best eye relief position.
  - 3) Secure the combo by tightening the two thumb nuts on the side of the Flat Top Adaptor.

## D. UNDERSTANDING THE RETICLE

- Each scope has a reticle for aiming. A reticle is a thin planar component disposed perpendicular to the optical axis inside the main tube. It is made by etched metal film or etched glass. The former is called Wire Reticle, and the latter is called Etched Glass Reticle.
- For all current Leapers riflescopes, the reticle is on the second image plane. The reticle doesn't change when the magnification is adjusted. Therefore, the dimension that the reticle occupies on the image of the target is dependent on the magnification.
- Leapers offers a variety of reticles for different scopes. Below is the introduction of the reticles.

### TARGET DOT RETICLE



Target Dot reticle consists of a single floating dot in the center as the aiming point with the least visual distraction. It is commonly used for quick aiming applications with lower demand for pin-point accuracy. The shooter aims by pointing the dot on the target. For Leapers rifle scope, the dot size is about 2MOA.

### CIRCLE DOT RETICLE



Circle Dot reticle includes a floating circle and a dot in the center. The circle draws the eye to the target and the dot indicates the exact aiming point. Circle Dot reticle is ideal for shotgun shooting, fly hunting as well as tactical applications which require quick target acquisition.

### DUPLEX RETICLE



Duplex reticle consists of thin crosshairs in the center and four posts extending to the reticle perimeter from the edges of the thin crosshairs. The thicker posts stand out against the background, while the thin crosshairs are for precise aiming and better view of the area of interest on the target. Duplex reticle could be etched on glass or etched from metal thin film. Accordingly, the center crosshair may be floating or connected to the outer bars.

### PRO 5-STEP RETICLE



Pro 5-step reticle is designed for crossbows, but can also be used in other applications such as rifles, airguns, etc. The reticle consists of five horizontal lines and a vertical line. And there is a thin crosshair in the center. If used on crossbows, the horizontal lines are for aiming at 10, 20, 30, 40 and 50-yard distances. The lines are calibrated for 300fps crossbows. The user needs to find out the exact yardage of each line during zeroing process.

#### Zeroing the Pro 5-Step Reticle Scope:

If used on a rifle or an airgun, zero a scope with Pro 5-step Reticle as you would with a regular scope (please refer to the Zeroing section).

If used on a crossbow, follow the steps below to zero a scope with Pro 5-step Reticle:

- Place a target 10 yards away, aim at the center of the target with the center crosshair and fire a few test shots.
- Adjust the windage and elevation until you hit the bullseye (please refer to Zeroing section for W/E adjustment).
- Place the target 20 yards away, still aim with the center crosshair and shoot. Make minor adjustment to windage and elevation if needed.
- Walk back 8-10 yards and fire shots at the center of the target to determine the accurate yardage of the next descending crosshair line. Repeat this for each of the 4 descending crosshair lines.

### MIL-DOT RETICLE



Mil-dot reticle is the most widely used reticle on Leapers riflescopes which provides range estimating capability. The reticle has a big crosshair throughout the reticle and multiple dots spread equally apart on the lines in the central area. The distance between two adjacent dots is designed to be 1 milli-radian or 3.44MOA at 10X.

The regular mil-dot reticle on the market usually has 4 dots on each direction. Leapers scopes usually has 7 or 9 dots on each direction to provide more flexibility in range estimating. For mil-dot reticle with 9 dots on each direction, if you count the 2 inner tips of the opposite crosshairs, there are 19 aiming points or totally 21 including the inner tips.

- ▶ Range estimating requires common knowledge/experience about your target's actual width or height.

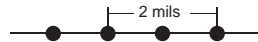

- ▶ 1 mil in a scope reticle is the distance from the center of one dot to the center of the next dot.

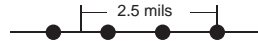

- ▶ Set your scope at 10X or the proper power specified by the mil-dot chart. Place the center of the dot against one edge of the target and measure to the opposite edge of the target.
- ▶ Once the target has been measured in mils, depending on the scope model, a formula is available to estimate the distance of the target. An example formula for 4-16X40 Full Size Scope is provided here for your reference:

$$\frac{\text{Height or Width of Target in Meters} \times 1000}{\text{Height or Width of Target in Mils}} = \text{Range in Meters (1M = 1.0936 Yards)}$$

- ▶ For accurate range estimating the size of the target must be known.
- ▶ Each model comes with its own formula and a pre-calculated mil-dot table of most used distance estimates to aid the user.

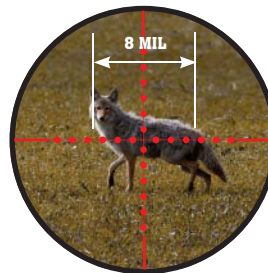

#### Example:

Total Number of Dots Occupied: 8  
Target Category: Prairie Wolf  
Estimated Size of the Target: 0.8 meter



$$\frac{\text{Width of Target in Meters} \times 1000}{\text{Width of Target in Mils}} = \text{Range in Meters}$$



$$\frac{0.8 \text{ meter} \times 1000}{8} = 100 \text{ Meters}$$

## E. ADJUSTING DIOPTER (Eye Piece Adjustment)

Dioper adjustment provides additional focus adjustment to adapt the scope to your eyesight.

1. Dioper adjustment ring is located at the ocular end of the scope. Aim the scope at your target, hold still and turn the dial ring clockwise or counter-clockwise until both the crosshair and the target are in the sharpest focus.

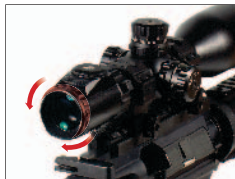

**Note:** Different individuals will have different eye focus which will result in different dioper setting. A person will use different dioper settings with or without eye glasses.

## F. INSTALLING BATTERY (For Reticle Intensified Models Only)

1. The battery is housed inside the EZ-TAP Battery housing or the side wheel Red/Green Illumination Rheostat.
2. Firmly hold the housing or the Rheostat with 2 fingers.
3. Use your other hand to open the battery compartment by unscrewing the top cap.
4. Remove the battery (if there is one) and install a new one. Make sure the positive (+) side is facing up.
5. Replace the cap and screw it clockwise to tighten.



F-1. EZ-TAP



F-2. Side Rheostat

## G. ADJUSTING RETICLE ILLUMINATION

(For Reticle Intensified Models Only)



G-1. Standard Rheostat



G-2. Compact Rheostat



G-3. EZ-TAP® Console

### G-1 and G-2 Illumination Adjustment

Dial the Rheostat to turn on the illumination and verify its color and brightness at each position.

### G-3 Illumination Adjustment (RGB Models or IE Models)

#### Memory Feature

When turned on, G-3 illuminated reticle shows the same color and brightness you last used.



#### Turn On/Off

1. Press either the **G** or **R** button to turn on the light.
2. Press and hold either the **G** or **R** button for 1 second to turn off the light.
3. Light will go off after 1 hour with no action.



#### Operating in the RGB Mode

1. Press the **R** button to turn the red light on or to change brightness of the red light.
2. Press the **G** button to turn the green light on or to change brightness of the green light.



#### Switching between RGB and Multi-Color Modes for IE Models

1. Press BOTH **G** & **R** buttons at the same time for less than 1 second.



#### Operating in Multi-Color Mode for IE Models

1. Press the **R** button to change the color along the color axis in the Color Index Table.
2. Press the **G** button to change the color along the intensity axis in the Color Index Table.



Color Index Table						
R Button	G Button					Intensity →
	Magenta	Thistle	Plum	Violet	Orchid	Purple
Pink	Rosy Brown	Coral	Crimson	Brown	Maroon	
Yellow	Khaki	Orange	Golden Rod	Chocolate	Olive	
Law Ngreen	Plae Green	Spring Green	Olive Drab	Sea Green	Forest Green	
Cyan	Azure	Turquoise	Cadet Blue	Dark Cyan	Teal	
Blue	Skyblue	Dodger Blue	Indigo	Midnight Blue	Navy	

## H. ADJUSTING MAGNIFICATION (For Variable Power Scopes Only)

1. For variable power scopes, there is a power ring in front of the eyepiece assembly. To change magnification, turn the ring to align the desired number on the ring with the index dot on the main tube.
2. The lower power provides wider field of view for quick aiming at close range. The higher power is for precise long-range aiming. When the numbers on the ring is not visible under low light condition, turn the ring left to increase the power, or turn the ring right to decrease the power.
3. **Note:** Never loosen the screw in the power ring. Doing so will break the sealing of the scope and destroy the fogproof feature. The power ring can't be disassembled and don't try to lubricate it. Any such action will void the warranty.



H-1. Adjusting Power Ring



H-2. Power Ring Screw

## I. ADJUSTING PARALLAX AND FOCUS (For Models with AO Only)



I-1. Front AO Adjustment



I-2. Side Wheel Adjustable Turret (SWAT) AO



I-3. SWAT AO Big Wheel (Optional)

1. Find the proper type of dial from the images above.
2. Aim the scope at your target.
3. Adjust the eyepiece until both the crosshair and the target are in sharpest focus.
4. Dial the Parallax Adjustment Ring, Side Wheel or Big Wheel, depending on what is available on your model, to the desired distance setting until the target is in the sharpest focus and the center of the crosshair stays on the target while you examine the image by slightly moving your head.

## J. ZEROING

The purpose of zeroing the scope is to ensure that the scope is aligned with the impact point of the pellet or bullet from the rifle. Before zeroing the scope, read the following adjustment knob instructions carefully.

**Note:** For crossbow scopes with PRO 5-STEP Reticle, please also refer to section D for more zeroing details.



J-1. Sniper W/E



J-2. TF2 Tool-free W/E



J-3. Coin-dial W/E



J-4. True Hunter W/E  
(Turret Color May Vary)



J-5. Finger Adjustable W/E



J-6. Lockable W/E  
(Turret Color May Vary)

**Note:** Each click of adjustment for the windage or elevation knob moves the impact point by the amount shown in the table below:

	25yds	35yds	50yds	100yds	200yds
Inches of Movement per Click in Windage/Elevation Models with 1/2 in. Per Click @ 100 Yards	1/8	7/40	1/4	1/2	1
Inches of Movement per Click in Windage/Elevation Models with 1/4 in. Per Click @ 100 Yards	1/16	7/80	1/8	1/4	1/2
Inches of Movement per Click in Windage/Elevation Models with 1/8 in. Per Click @ 100 Yards	1/32	7/160	1/16	1/8	1/4

**Note:** Since climatic conditions such as altitude, temperature, wind and rain can affect the pellets or bullets trajectory, you may experience some deviation in the exact settings during different shooting sessions.

### ★ J-1 Sniper W/E Operation

- The Windage and Elevation Adjustment Target Knobs have a unique Resetting Screw design. An Allen wrench is provided with the scope for adjustment.

#### 2. ZERO LOCKING (W/E are "locked" for a new scope.)

Finger tighten the Zero Locking Ring by rotating clockwise by 40 - 70 degrees. Do not over-tighten. When the Zero Locking Ring is tightened, the windage or elevation adjustment knob is "locked". The knob will not rotate, preventing any accidental movement to lose zero.

#### 3. ZEROING

Un-lock the adjustment knobs by turning the Zero Locking Ring counter clockwise by 40 - 70 degrees. Now, Windage/Elevation adjustment knobs can be rotated.

- Place a target 100 yards away. (35 yards for airgun scopes)
- Ideally, use a steadying device such as a bipod or shooting stand, set the scope at the highest magnification, aim at the center of the target and fire a test shot, if safe to do so.
- If the impact point of the pellet or bullet is exactly in the center of the target then the scope is zeroed. If it is not, you will need to adjust the reticle using the elevation and/or windage adjusters as follows:
  - Vertical Adjustment (Elevation) - Use your fingers to turn the adjusting knob as required. One click in either direction equals approximately 1/2, 1/4 or 1/8 inch at 100 yards (check exact specifications for your scope).
  - Horizontal Adjustment (Windage) - Use your fingers to rotate the adjusting knob as required. One click in either direction equals approximately 1/2, 1/4 or 1/8 inch at 100 yards (check exact specifications for your scope).

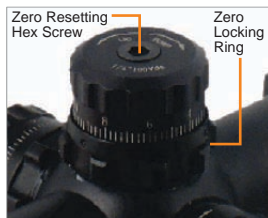

- Having adjusted the windage and elevation as required, fire, if safe to do so, another test shot. Keep adjusting and test firing until the test shot impacts on the center of the target when the reticle is on the center of the target. This is vital for accurate shooting.

## 4. ZERO RESETTING

Once your scope is zeroed, rotate the Zero Locking Ring to lock Zero. The "0" marking may not be facing you at the original center position now. Optionally, you can use the following steps to Reset Zero by rotating the "0" marking to the center positions:

- Ensure zero is "locked".
- Use the Allen wrench to turn the Zero Resetting Hex Screw by 180-360 degrees to dis-engage the W/E knobs. (IMPORTANT: Be gentle with the screw movement. Do not over extend the rotation. Stop when meeting resistance in the rotation)
- When the W/E knob is dis-engaged, rotating the knob will not produce any clicking sound and will not affect zero. You can re-position the "0" marking to the center position. (If you get clicks when rotating the W/E knob, the knob was not properly dis-engaged. You need to go back and re-start from zeroing your scope.)
- Before tightening the Zero Resetting Hex Screw, turn the Zero Locking Ring counter-clockwise by 40-70 degrees to un-lock zero.
- Be careful to keep the W/E knob still now that it is un-locked. Use the Allen wrench to gently tighten down the Zero Resetting Hex Screw to complete Zero Resetting. (If you get clicks while tightening the screw, you will need to go back and re-start from zeroing your scope.)
- IMPORTANT: Rotate the Locking Ring clockwise to lock zero immediately.

**Important Note:** When turning the Zero Resetting Screw loose to dis-engage W/E, zero has to be "locked". When tightening the Zero Resetting Screw to engage W/E, zero cannot be locked. Scope damage may occur if the steps are not followed.

### ★ J-2 TF2 W/E Operation



- The Windage and Elevation Adjustment Knobs have a unique 2-stage Tool-free design. A new scope comes with both knobs secured down in the zero-locking mode. Pulling the knobs upward allows for windage/elevation adjustment.

#### 2. ZERO LOCKING (W/E are "locked" for a new scope.)

When the adjustment knob is pushed down, the knob is "locked" and cannot be rotated. This will prevent any accidental movement to lose zero.

**NOTE:** To lock an adjustment knob requires proper gear engagement internally. Before pressing the knob down to lock, use minor force to push to get the feel of resistance. If tough to push down, make very slight rotational adjustment (no clicking) to locate the right position to press down. DO NOT force the lock-down.

#### 3. ZEROING

Pull up the windage and elevation adjustment knobs to allow for adjustment.

- Zeroing with a Bore Sighter
  - Follow the instructions that came with your bore sighter and install it in the muzzle of your rifle lining it up with the scope as close as possible.
  - Pull the windage/elevation knob out for adjustment.
  - Sighting through the scope as though you were going to shoot and dial the knobs to make adjustment for the windage or elevation until the crosshair matches the bore sighter.
  - Push the windage or elevation knob down to lock the zero position.
  - Remove the bore sighter from the muzzle. You are ready for zeroing the target.



- ii. Zeroing on the Target
  - a. Place a target 100 yards away (35 yards for air gun).
  - b. Ideally, use a steadying device such as a shooting stand or bipod, set the scope at highest magnification, aim at the center of the target, fire a test shot, if safe to do so.
  - c. If the impact point of the pellet or bullet is exactly in the center of the target then the scope is zeroed. If not, you will need to adjust the reticle using the elevation and/or windage adjustment as follows:
  - d. Vertical adjustment (Elevation) – Use your fingers to turn the adjusting knob as required. One click in either direction equals approximately 1/2, 1/4 or 1/8 inch at 100 yards depending on the model.
  - e. Horizontal adjustment (Windage) - Use your fingers to rotate the adjusting knob as required. One click in either direction equals approximately 1/2, 1/4 or 1/8 inch at 100 yards depending on the model.
  - f. Having adjusted the windage and elevation as required, fire, if safe to do so, another test shot. Keep adjusting and test firing until the test shot hit the target center.
  - g. Now the scope should be zeroed. Make sure to lock both elevation and windage knobs.

### ★ J-3, J-4, J-5 W/E Operation

#### WINDAGE/ELEVATION DIALING INSTRUCTION



**J-3 Use a flat head screwdriver to adjust the windage and elevation.**



**J-4 Apply gentle force on the rim and dial the knob.**



**J-5 Apply gentle force on the plastic tab and dial the knob.**

1. **ZEROING** - Unscrew and remove the cap of the adjustment knob. Put the cap away in a safe place.
  - i. Zeroing with a Bore Sighter
    - a. When the turret is ready for adjustment, you will be able to dial and have a clear audible click.
    - b. Follow the instruction of your bore sighter and install it in the muzzle of your rifle, lining it with the scope as closely as possible.
    - c. If applicable, turn on the illumination and set it at your preferred color and brightness.
    - d. Sighting through the scope as though you were going to shoot and dial the knobs to make adjustment for the elevation and/or windage until the crosshair matches the bore sighter.
  - ii. Zeroing on a Target
    - a. Place a target 100 yards away (35 yards for air gun).
    - b. Use a steadying device such as a shooting stand or bipod, set the illumination to your preferred settings, aim at the center of the target and fire a test group shot, if safe to do so.
    - c. If the impact point of the test shot is exactly in the center of the target then the scope is zeroed. If not, you will need to adjust the reticle using the elevation and/or windage adjustment. Follow the Point of Impact (POI) direction on the turret to dial the knob accordingly.
    - d. Having adjusted the elevation and windage as required, fire, if safe to do so, another test group. Keep adjusting and test firing until the test shot hit the target center in an acceptable small grouping.
  - iii. Now the scope should be zeroed. Make sure to replace both elevation and windage knob caps.

### ★ J-6 Lockable W/E Operation

1. The Windage and Elevation Adjustment Target Knobs have a unique Locking Screw design. An Allen wrench is provided with the scope for adjustment.

#### **WARNING:**

DO NOT over-loosen the locking screws! It may cause the face cover to fall off if screws are backed out too far. If, by mistake, the face lid fell off when you are loosening the screws, please follow instructions below to replace the face cover.

- A. Lock both screws down, making sure that they are flush with the surface.
- B. Apply a little loctite or similar adhesive on the flat surface of the knob. Make sure that no adhesive gets into the screw holes or onto the screws.
- C. Carefully place the face cover back on the knob and align with the locking holes properly. Firmly press the face cover to achieve full contact and wait a few seconds to let the cover adhere to the flat surface of the knob.

#### 2. **ZERO LOCKING (W/E are "locked" for a new scope.)**

- i. Unscrew and remove the cap of the adjustment knob. Put the cap away in a safe place. Gently dial the knob and test if it is locked. If not, you can skip section ii.
- ii. To Unlock: Locate the two locking screws as shown on the right. Use the included small Allen wrench to unlock both locking screws by turning them counterclockwise 1/4 revolution.
- iii. To Lock: Use the included small Allen wrench to fully lock down both screws by turning them clockwise. It is recommended that you gradually lock both screws alternately until they are fully and evenly locked.



#### 3. **ZEROING** - Unlock the adjustment knob to allow for adjustment.

- i. Zeroing with a Bore Sighter
  - a. When the turret is ready for adjustment, you will be able to dial and have a clear audible click.
  - b. Follow the instruction of your bore sighter and install it in the muzzle of your rifle, lining it with the scope as closely as possible.
  - c. If applicable, turn on the illumination and set it at your preferred color and brightness.
  - d. Sighting through the scope as though you were going to shoot and dial the knobs to make adjustment for the elevation and/or windage until the crosshair matches the bore sighter.
- ii. Zeroing on a Target
  - a. Place a target 100 yards away (35 yards for air gun).
  - b. Use a steadying device such as a shooting stand or bipod, set the illumination to your preferred settings, aim at the center of the target and fire a test group shot, if safe to do so.
  - c. If the impact point of the test shot is exactly in the center of the target then the scope is zeroed. If not, you will need to adjust the reticle using the elevation and/or windage adjustment. Follow the Point of Impact (POI) direction on the turret to dial the knob accordingly.
  - d. Having adjusted the elevation and windage as required, fire, if safe to do so, another test group. Keep adjusting and test firing until the test shot hit the target center in an acceptable small grouping.
  - e. Now the scope should be zeroed. Make sure to lock both elevation and windage knobs and replace the knob caps.



Leapers, Inc., headquartered in Michigan, U.S.A., has been in the business of supplying shooting, hunting and outdoor gear since 1991. We set uncompromised high standards for all of our business operations.

Our goal is to provide a total solution for any line of products we offer. We pay close attention to industry trends and customer feedback, with a focus on making the best-in-class niche products available for hunting, shooting and outdoor enthusiasts like you.

**EXPLORE  
MORE  
AT**

**WWW.LEAPERS.COM**



**www.LEAPERS.com**  
**32700 Capitol Street, Livonia, MI**  
**48150, U.S.A.**  
Tel:(734)542-1500  
Fax:(734)542-7095  
Email:office@leapers.com